



























Machine	Explode	Code	Description
Apuro Commercial Microwave - Programmable Heavy Duty	1		Cavity Assembly
Apuro Commercial Microwave - Programmable Heavy Duty	2	AM451	Splash Cover
Apuro Commercial Microwave - Programmable Heavy Duty	3	AP519	Inner Plate Cover
Apuro Commercial Microwave - Programmable Heavy Duty	4	AM166	Baseplate
Apuro Commercial Microwave - Programmable Heavy Duty	5	AK742	Control Panel Assembly
Apuro Commercial Microwave - Programmable Heavy Duty	6	AK747	Control Panel
Apuro Commercial Microwave - Programmable Heavy Duty	7		C/Panel Cover
Apuro Commercial Microwave - Programmable Heavy Duty	8		C/Panel Decoration Left
Apuro Commercial Microwave - Programmable Heavy Duty	9		C/Panel Decoration Right
Apuro Commercial Microwave - Programmable Heavy Duty	10	AK752	Membrane Switch
Apuro Commercial Microwave - Programmable Heavy Duty	11		Light Guide
Apuro Commercial Microwave - Programmable Heavy Duty	12	AM876	MI Assembly/Main PCB
Apuro Commercial Microwave - Programmable Heavy Duty	13		Metal Bracket
Apuro Commercial Microwave - Programmable Heavy Duty	14		MI Assembly
Apuro Commercial Microwave - Programmable Heavy Duty	15		Door Assembly incl. Door Seal
Apuro Commercial Microwave - Programmable Heavy Duty	16		Door Frame Drop Glue Assembly
Apuro Commercial Microwave - Programmable Heavy Duty	17	AK759	Latch
Apuro Commercial Microwave - Programmable Heavy Duty	18	AP201	Latch Spring
Apuro Commercial Microwave - Programmable Heavy Duty	18		Spring
Apuro Commercial Microwave - Programmable Heavy Duty	19		Glass Door Screen
Apuro Commercial Microwave - Programmable Heavy Duty	20		Door Panel
Apuro Commercial Microwave - Programmable Heavy Duty	21		Door Seal
Apuro Commercial Microwave - Programmable Heavy Duty	22		Door Decoration
Apuro Commercial Microwave - Programmable Heavy Duty	23		Handle
Apuro Commercial Microwave - Programmable Heavy Duty	24		Door Shaft
Apuro Commercial Microwave - Programmable Heavy Duty	25	AK780	Magnetron
Apuro Commercial Microwave - Programmable Heavy Duty	26	AK781	LED Lamp
Apuro Commercial Microwave - Programmable Heavy Duty	27	AK801	H.V.Transformers
Apuro Commercial Microwave - Programmable Heavy Duty	28	AK803	H.V.Capacitor
Apuro Commercial Microwave - Programmable Heavy Duty	29	AK807	H.V.Diode
Apuro Commercial Microwave - Programmable Heavy Duty	30	AK798	Fuse
Apuro Commercial Microwave - Programmable Heavy Duty	31	AK774	Noise Filter Assembly
Apuro Commercial Microwave - Programmable Heavy Duty	32		AUS Power Cord
Apuro Commercial Microwave - Programmable Heavy Duty	33	AK764	Thermostat Bracket
Apuro Commercial Microwave - Programmable Heavy Duty	34		Thermostat
Apuro Commercial Microwave - Programmable Heavy Duty	35	AK766	Thermostat
Apuro Commercial Microwave - Programmable Heavy Duty	36	AM796	Plastic Bracket
Apuro Commercial Microwave - Programmable Heavy Duty	37	AK788	Latch Board
Apuro Commercial Microwave - Programmable Heavy Duty	38	AK792	Interlock Lever
Apuro Commercial Microwave - Programmable Heavy Duty	39	AK793	Interlock Lever
Apuro Commercial Microwave - Programmable Heavy Duty	40	AK794	Interlock Lever
Apuro Commercial Microwave - Programmable Heavy Duty	41	AK784	Microswitch
Apuro Commercial Microwave - Programmable Heavy Duty	42	AK785	Microswitch
Apuro Commercial Microwave - Programmable Heavy Duty	43	AK812	Main Wire Harness
Apuro Commercial Microwave - Programmable Heavy Duty	44		Latch Spring

Machine	Explode	Code	Description
Apuro Commercial Microwave - Programmable Heavy Duty	45	AP220	Filter Net
Apuro Commercial Microwave - Programmable Heavy Duty	46		Back Plate Assembly
Apuro Commercial Microwave - Programmable Heavy Duty	47	AK771	Synchronous Motor
Apuro Commercial Microwave - Programmable Heavy Duty	48		Metal Cover
Apuro Commercial Microwave - Programmable Heavy Duty	49	AN444	Upper Stirrer Fan Assembly
Apuro Commercial Microwave - Programmable Heavy Duty	50	AN457	Lower Stirrer Fan Assembly
Apuro Commercial Microwave - Programmable Heavy Duty	51	AK816	Fan Assembly Left
Apuro Commercial Microwave - Programmable Heavy Duty	52	AK817	Fan Assembly Right
Apuro Commercial Microwave - Programmable Heavy Duty	53		Wind Guide
Apuro Commercial Microwave - Programmable Heavy Duty	54		Wind Guide
Apuro Commercial Microwave - Programmable Heavy Duty	55	AK776	Upper Air Duct
Apuro Commercial Microwave - Programmable Heavy Duty	56	AK777	Lower Air Duct
Apuro Commercial Microwave - Programmable Heavy Duty	57		Mounting Plate
Apuro Commercial Microwave - Programmable Heavy Duty	58		Wind Guide Cover Assembly
Apuro Commercial Microwave - Programmable Heavy Duty	59	AM452	Plastic Bracket
Apuro Commercial Microwave - Programmable Heavy Duty	60	AP588	Metal Cover
Apuro Commercial Microwave - Programmable Heavy Duty	61		Capacitor Holder
Apuro Commercial Microwave - Programmable Heavy Duty	62	AP573	Lamp Cover
Apuro Commercial Microwave - Programmable Heavy Duty	63		Cover
Apuro Commercial Microwave - Programmable Heavy Duty	64		Lamp Socket Bracket

Circuit Diagram

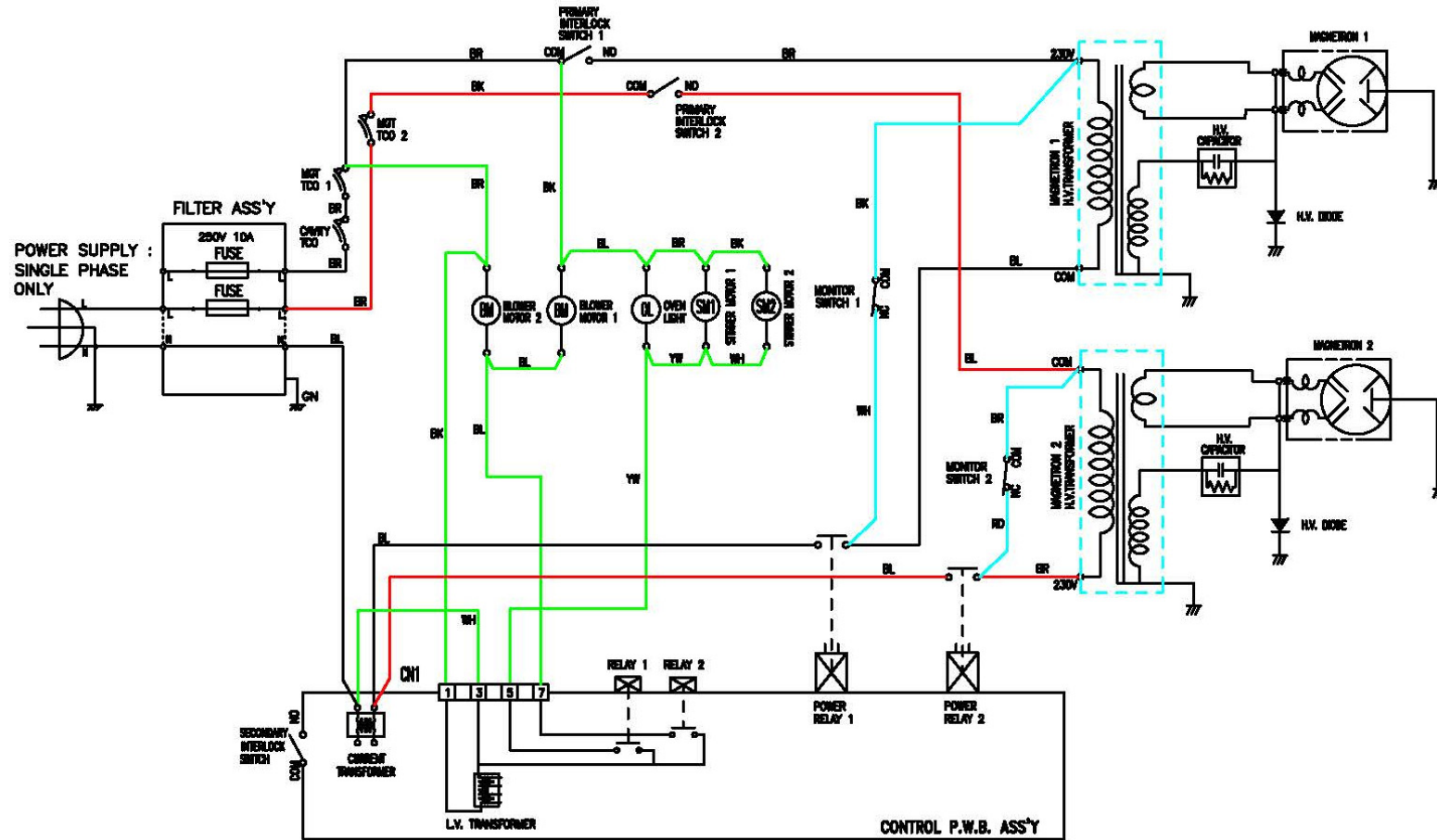

[CONDITION]
 DOOR : OPEN
 COOK : OFF

NOTE : BK : BLACK BL : BLUE
 RD : RED BR : BROWN
 WH : WHITE CN : GREEN
 YW : YELLOW